

Residential and Commercial  
**Roofing Product Solutions Catalog**



# QUALITY INNOVATION PERFORMANCE

IPS Corporation has long been recognized for its commitment to improving residential and commercial construction products. From introducing America's first plastic pipe solvent cement, the first plastic recessed Washing Machine Outlet Box, to the first adjustable multi-size roof vent flashing, IPS Corporation has always sought to help professional contractors work faster and smarter.

IPS leaves nothing to chance by using the highest-quality materials, which are fully tested for ultraviolet, ozone, and weather resistance. With continued devotion to research, product development, and superior service IPS will continue to bring innovative products with unsurpassed service to the roofing market.

IPS Corporation Roofing Products Division Focus:

.....  
Creating value for our customers

.....  
Product innovation

.....  
Superior workmanship

.....  
Unsurpassed customer service

.....  
Professionalism at all levels

Thank you for choosing IPS Corporation's Roofing Products!





# GALVANIZED FLASHINGS

## Multi-Size 4N1® Galvanized Steel Base Roof Flashings



81711

- 20 mil galvanized steel base
- 4 sizes in 1 for on-the-job convenience — fits pipes 1-1/4" to 4"
- Can be installed on 12/12 pitch roofs or higher dependent on vent pipe size, see specification sheet
- Large base and nailing flange for extra coverage in freeze-thaw climates
- Flexible PVC collar heat tested to 180°F, conforms to vent pipe creating a water-tight seal
- Tested for ultraviolet, ozone, and weather resistance
- Limited Lifetime Warranty for life of the current roof system

LISTINGS	PRODUCT	DESCRIPTION	MODEL	UNITS/CASE
	81711	4N1 12" x 16" Base – Mill Finish	GB41	20
	81890	4N1 12" x 16" Base – Brown	GB41BROWN	20
	81891	4N1 12" x 16" Base – Black	GB41BLACK	20
	81892	4N1 12" x 16" Base – Gray	GB41GRAY	20
	81880	4N1 18" x 18" Base – Mill Finish	GB4118	15

## Multi-Size 3N1® Galvanized Steel Base Roof Flashings



81710

- 20 mil galvanized steel base
- Multi size flashing fits 1-1/4" to 3"
- Can be installed on 12/12 pitch roofs or higher dependent on vent pipe size, see specification sheet
- Flexible PVC collar heat tested to 180°F, conforms to vent pipe creating a water-tight seal
- Tested for ultraviolet, ozone, and weather resistance
- Limited Lifetime Warranty for life of the current roof system



LISTINGS	PRODUCT	DESCRIPTION	MODEL	UNITS/CASE
	81710	3N1 10-3/4" x 14-1/2" Base – Mill Finish	GB31	20
	81851	3N1 10-3/4" x 14-1/2" Base – Brown	GB31BROWN	20
	81852	3N1 10-3/4" x 14-1/2" Base – Black	GB31BLACK	20
	81853	3N1 10-3/4" x 14-1/2" Base – Gray	GB31GRAY	20

## Standard Galvanized Steel Base Roof Flashings



81850

- 20 mil galvanized steel base
- Can be installed on 12/12 pitch roofs or higher dependent on vent pipe size, see specification sheet
- Flexible PVC collar heat tested to 180°F, conforms to vent pipe creating a water-tight seal
- Tested for ultraviolet, ozone, and weather resistance
- Limited Lifetime Warranty for life of the current roof system

LISTINGS	PRODUCT	DESCRIPTION	MODEL	UNITS/CASE
	81850	8-3/4" x 12-1/2" Base for 1-1/4" or 1-1/2" Vent Pipe	GB1	20
	81855	8-3/4" x 12-1/2" Base for 2" Vent Pipe	GB2	20
	81860	10-3/4" x 14-1/2" Base for 3" Vent Pipe	GB3	20
	81865	12" x 16" Base for 4" Vent Pipe	GB4	20
	81870	8-3/4" x 12-1/2" Base for -1/2", -3/4" or 1" Tubing	GB5	20



**Caution:** Ensure any sealant, mastic, or adhesive used is compatible with Flexible PVC, Polypropylene, EPDM, and Silicone. Do not apply any substances on the collar portion of the flashing.

## Multi-Size 4N1® Aluminium Base Roof Flashings

- 25 mil aluminum base
- 4 sizes in 1 for on-the-job convenience — fits pipes 1-1/4" to 4"
- Can be installed on 12/12 pitch roofs or higher dependent on vent pipe size, see specification sheet
- Large base and nailing flange for extra coverage in freeze-thaw climates
- Flexible PVC collar heat tested to 180°F, conforms to vent pipe creating a water-tight seal
- Tested for ultraviolet, ozone, and weather resistance
- Limited Lifetime Warranty for life of the current roof system



81716

LISTINGS	PRODUCT	DESCRIPTION	MODEL	UNITS/CASE
	81716	4N1 12" x 16" Base – Mill Finish	AB41	20
	81893	4N1 12" x 16" Base – Brown	AB41BROWN	20
	81894	4N1 12" x 16" Base – Black	AB41BLACK	20
	81895	4N1 12" x 16" Base – Gray	AB41GRAY	20
	81934	4N1 18" x 18" Base – Mill Finish	AB4118	15

## Multi-Size 3N1® Aluminium Base Roof Flashings

- 25 mil aluminum base
- Multi size flashing fits 1-1/4" to 3"
- Can be installed on 12/12 pitch roofs or higher dependent on vent pipe size, see specification sheet
- Flexible PVC collar heat tested to 180°F, conforms to vent pipe creating a water-tight seal
- Tested for ultraviolet, ozone, and weather resistance
- Limited Lifetime Warranty for life of the current roof system



81715



LISTINGS	PRODUCT	DESCRIPTION	MODEL	UNITS/CASE
	81715	3N1® 10-3/4" x 14-1/2" Base – Mill Finish	AB31	20
	81901	3 N 1® 10-3/4" x 14-1/2" Base – Brown	AB31BROWN	20
	81902	3 N 1® 10-3/4" x 14-1/2" Base – Black	AB31BLACK	20
	81903	3 N 1® 10-3/4" x 14-1/2" Base – Gray	AB31GRAY	20

## Standard Aluminium Base Roof Flashings

- 25 mil aluminum base
- Can be installed on 12/12 pitch roofs or higher dependent on vent pipe size, see specification sheet
- Flexible PVC collar heat tested to 180°F, conforms to vent pipe creating a water-tight seal
- Tested for ultraviolet, ozone, and weather resistance
- Limited Lifetime Warranty for life of the current roof system



81900

LISTINGS	PRODUCT	DESCRIPTION	MODEL	UNITS/CASE
	81900	8-3/4" x 12-1/2" Base for 1-1/4" or 1-1/2" Vent Pipe	AB1	20
	81905	8-3/4" x 12-1/2" Base for 2" Vent Pipe	AB2	20
	81910	10-3/4" x 14-1/2" Base for 3" Vent Pipe	AB3	20
	81915	12" x 16" Base for 4" Vent Pipe	AB4	20

**Caution:** Ensure any sealant, mastic, or adhesive used is compatible with Flexible PVC, Polypropylene, EPDM, and Silicone. Do not apply any substances on the collar portion of the flashing.

# HARD PLASTIC FLASHINGS

## Multi-Size 4N1™ Hard Plastic Base Roof Flashings

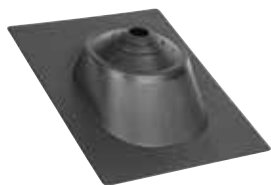

81709

- Thermoplastic hard base
- 4 sizes in 1 for on-the-job convenience — fits pipes 1-1/4" to 4"
- Can be installed on 12/12 pitch roofs or higher dependent on vent pipe size, see specification sheet
- Larger base for extra coverage (12" x 16")
- Flexible PVC collar heat tested to 180°F, conforms to vent pipe creating a water-tight seal
- Tested for ultraviolet, ozone, and weather resistance
- Limited Lifetime Warranty for life of the current roof system

LISTINGS	PRODUCT	DESCRIPTION	MODEL	UNITS/CASE
 	81709	4N1 Hardbase Flashing	HB41	20

## Multi-Size 3N1™ Hard Plastic Base Roof Flashings



81700

- Thermoplastic hard base
- Multi-size fits 1-1/4" to 3"
- Can be installed on 12/12 pitch roofs or higher dependent on vent pipe size, see specification sheet
- Flexible PVC collar heat tested to 180°F, conforms to vent pipe creating a water-tight seal
- Tested for ultraviolet, ozone, and weather resistance
- Limited Lifetime Warranty for life of the current roof system



LISTINGS	PRODUCT	DESCRIPTION	MODEL	UNITS/CASE
 	81700	3 N 1® 11-1/8" x 15" Base	HB31	20

## Standard Hard Plastic Base Roof Flashings



81709



- Thermoplastic hard base
- Can be installed on 12/12 pitch roofs or higher dependent on vent pipe size, see specification sheet
- Flexible PVC collar heat tested to 180°F, conforms to vent pipe creating a water-tight seal
- Tested for ultraviolet, ozone, and weather resistance
- Limited Lifetime Warranty for life of the current roof system

LISTINGS	PRODUCT	DESCRIPTION	MODEL	UNITS/CASE
 	81750	9-1/4" x 13" Base for 1-1/4" or 1-1/2" Vent Pipe	HB1	20
	81751	11-1/8" x 15" Base for 1-1/4" or 1-1/2" Vent Pipe	HB1LB	20
	81755	9-1/4" x 13" Base for 2" Vent Pipe	HB2	20
	81756	11-1/8" x 15" Base for 2" Vent Pipe	HB2LB	20
	81760	11-1/8" x 15" Base for 3" Vent Pipe	HB3	20
	81765	12" x 15-1/2" Base for 4" Vent Pipe	HB4	20

**Caution:** Ensure any sealant, mastic, or adhesive used is compatible with Flexible PVC, Polypropylene, EPDM, and Silicone. Do not apply any substances on the collar portion of the flashing.

## Multi-Size 3N1 and 3N4 All Flexible Base Roof Flashings

- All flexible, one-piece base and collar
- Can be installed on 12/12 pitch roofs or higher dependent on vent pipe size, see specification sheet
- Flexible PVC heat tested to 180°F, conforms to vent pipe creating a water-tight seal
- Tested for ultraviolet, ozone, and weather resistance
- Limited Lifetime Warranty for life of the current roof system



LISTINGS	PRODUCT	DESCRIPTION	MODEL	UNITS/CASE
 	81705	3N1® 10" x 13-1/4" Base for 1-1/4", 1-1/2", 2" or 3" Vent Pipe	FB31	20
	81707	12" x 14-3/4" Base for 3" or 4" Vent Pipea	FB34	20



81705

## Standard All Flexible Roof Flashings

- All flexible, one-piece base and collar
- Can be installed on 12/12 pitch roofs or higher dependent on vent pipe size, see specification sheet
- Flexible PVC heat tested to 180°F, conforms to vent pipe creating a water-tight seal
- Tested for ultraviolet, ozone, and weather resistance
- Limited Lifetime Warranty for life of the current roof system

LISTINGS	PRODUCT	DESCRIPTION	MODEL	UNITS/CASE
 	81800	9" x 11 3/8" Base for 1-1/4" or 1-1/2" Vent Pipe	FB1	20
	81805	9" x 11 3/8" Base for 2" Vent Pipe	FB2	20
	81810	10" x 13-1/4" Base for 3" Vent Pipe	FB3	20
	81815	12" x 14 -3/4" Base for 4" Vent Pipe	FB4	20



81800

# COPPER FLASHING

## Multi-Size 4N1® Copper Base Roof Flashings

- 16 ounce copper base
- 4 sizes in 1 for on-the-job convenience — fits pipes 1 1/4" to 4"
- Can be installed on 12/12 pitch roofs or higher dependent on vent pipe size, see specification sheet
- Large base and nailing flange for extra coverage in freeze-thaw climates
- Flexible PVC collar heat tested to 180°F, conforms to vent pipe creating a water-tight seal
- Tested for ultraviolet, ozone, and weather resistance
- Limited Lifetime Warranty for life of the current roof system

LISTINGS	PRODUCT	DESCRIPTION	MODEL	UNITS/CASE
 	81942	4N1 12" x 16" Base — Copper	CB41	5
	81885	4N1 12" x 16" Base — Copper, Single Pack	CB41S	1



81942

**Caution:** Ensure any sealant, mastic, or adhesive used is compatible with Flexible PVC, Polypropylene, EPDM, and Silicone. Do not apply any substances on the collar portion of the flashing.

# METAL ROOF FLASHINGS

## Metal Roof Flashings

- Sleeve Flexibility: Absorbs vibration and pipe movement caused by expansion/contraction
- Easy On-site Customization: Can accommodate all normal installations
- Adaptable Base: Designed to mold to most panel configurations and roof pitches regardless of pipe location
- Weather Protection: Made of EPDM or high-temperature silicone, these flashings are compounded specifically for maximum resistance to weathering due to ozone and ultraviolet light
- Fits any metal roof pitch to 45° for Square Base and 40° for Round Base
- EPDM is Lab Tested and certified: IAPMO PS64-2012ea1



PRODUCT	DESCRIPTION	MODEL	UNITS/CASE
<b>Square Base</b>			
81455	#3, Gray, EPDM, for pipe sizes 0"–5-3/4"	MRF3GSQ	10
81456	#4, Gray, EPDM, for pipe sizes 2-3/4"–7"	MRF4GSQ	10
81457	#5, Gray, EPDM, for pipe sizes 3-3/4"–7-3/4"	MRF5GSQ	10
81458	#6, Gray, EPDM, for pipe sizes 4-3/4"–10"	MRF6GSQ	10
81459	#7, Gray, EPDM, for pipe sizes 6"–11"	MRF7GSQ	10
81845	#3, Black, EPDM, for pipe sizes 0"–5-3/4"	MRF3BSQ	6
81460	#4, Black, EPDM, for pipe sizes 2-3/4"–7"	MRF4BSQ	10
81461	#5, Black, EPDM, for pipe sizes 3-3/4"–7-3/4"	MRF5BSQ	10
81462	#6, Black, EPDM, for pipe sizes 3-3/4"–7-3/4"	MRF6BSQ	10
81463	#7, Black, EPDM, for pipe sizes 6"–11"	MRF7BSQ	10
81464	#3, Terra Cotta, Silicone, for pipe sizes 0"–5-3/4"	MRF3TCSQ	6
81465	#4, Terra Cotta, Silicone, for pipe sizes 2-3/4"–7"	MRF4TCSQ	6
81466	#3, Black, Silicone, for pipe sizes 0"–5-3/4"	MRF3BSSQ	6
81467	#4, Black, Silicone, for pipe sizes 2-3/4"–7"	MRF4BSSQ	6
<b>Round Base</b>			
81820	#1, Gray, EPDM, for pipe sizes 0"–2-3/8"	MRF1GRD	10
81821	#2, Gray, EPDM, for pipe sizes 1-3/4"–3"	MRF2GRD	10
81822	#3, Gray, EPDM, for pipe sizes 0"–5"	MRF3GRD	10
81823	#4, Gray, EPDM, for pipe sizes 3"–6-1/4"	MRF4GRD	10
81824	#5, Gray, EPDM, for pipe sizes 4-1/4"–7-1/2"	MRF5GRD	10
81825	#6, Gray, EPDM, for pipe sizes 5"–9"	MRF6GRD	10
81826	#7, Gray, EPDM, for pipe sizes 6"–11"	MRF7GRD	10
81468	#1, Black, EPDM, for pipe sizes 0"–2-3/8"	MRF1BRD	10
81469	#2, Black, EPDM, for pipe sizes 1-1/4"–3"	MRF2BRD	10
81470	#3, Black, EPDM, for pipe sizes 0"–5"	MRF3BRD	10
81471	#4, Black, EPDM, for pipe sizes 3"–6-1/4"	MRF4BRD	10
81472	#5, Black, EPDM, for pipe sizes 3"–6-1/4"	MRF5BRD	10
81473	#6, Black, EPDM, for pipe sizes 5"–9"	MRF6BRD	10
81474	#7, Black, EPDM, for pipe sizes 6"–11"	MRF7BRD	10
81475	#3, Terra Cotta, Silicone, for pipe sizes 0"–5"	MRF3TCSR	6
81476	#5, Terra Cotta, Silicone, for pipe sizes 4-1/4"–7-1/2"	MRF5TCSR	6
81477	#3, Black, Silicone, for pipe sizes 0-5"	MRF3BSRD	6
81478	#5, Black, Silicone, for pipe sizes 4-1/4"–7-1/2"	MRF5BSRD	6
<b>Retro Fit Round Base</b>			
81494	#1, Gray, EPDM, for pipe sizes 3/4"–2-3/4"	MRF1GRDRF	10
81495	#2, Gray, EPDM, for pipe sizes 2"–7-1/4"	MRF2GRDRF	10
81496	#3, Gray, EPDM, for pipe sizes 3-1/4"–10"	MRF3GRDRF	10
81828	#1, Black, EPDM, for pipe sizes 3/4"–2-3/4"	MRF1BRDRF	10
81829	#2, Black, EPDM, for pipe sizes 2"–7-1/4"	MRF2BRDRF	10
81830	#3, Black, EPDM, for pipe sizes 3-1/4"–10"	MRF3BRDRF	10

Caution: Ensure any sealant, mastic, or adhesive used is compatible with Flexible PVC, Polypropylene, EPDM, and Silicone. Do not apply any substances on the collar portion of the flashing.





## Multi-Size 4N1™ Rain Collar

- Can be used to repair the elastomer sealing collar on all types of residential "no caulk" roof vent flashings quickly and easily
- Eliminates the need for a mastic or caulking type messy repair job
- Can be used to instantly repair a leak during a wet period, until the flashing can be replaced at a later time
- Large size covers the entire existing elastomer collar
- Fully tested for ultraviolet, ozone and weather resistance
- Individual sizes and multi-size adjustable models available
- Better appearance than a mastic



81721

LISTINGS	PRODUCT	DESCRIPTION	MODEL	UNITS/CASE
 	81721	4N1® Collar for 1-1/4", 1-1/2", 2", 3" or 4" Vent Pipe	RC41	20

## Standard Size Rain Collars

- Can be used to repair the elastomer sealing collar on all types of residential "no caulk" roof vent flashings quickly and easily
- Eliminates the need for a mastic or caulking type messy repair job
- Fully tested for ultraviolet, ozone and weather resistance
- Better appearance than a mastic repair job
- Can be used to instantly repair a leak during a wet period, until the flashing can be replaced at a later time
- Large size covers the entire existing elastomer collar
- For patching leaking no-caulk-style flashings
- Individual size and multi-size adjustable models available



81725



PRODUCT	DESCRIPTION	MODEL	UNITS/CASE
81725	Collar for 1-1/2" Vent Pipe	RC1	100
81730	Collar for 2" Vent Pipe	RC2	100
81735	Collar for 3" Vent Pipe	RC3	75
81740	Collar for 4" Vent Pipe	RC4	75
81745	Collar for 1/2", 3/4", 1" Vent Pipe	RC5	100

## Low-Profile Collars

- For all metal style roof flashings
- Designed to fit all metal coned roof jacks/flashings 1" – 4"
- Requires no mastic, caulking or taping for a total waterproof seal
- Low-profile size
- Manufactured using a special EPDM material with UV inhibitor
- Limited Lifetime Warranty for life of the current roof system



81739

LISTINGS	PRODUCT	DESCRIPTION	MODEL	UNITS/CASE
	81739	Low Profile Collar for 1" Vent Pipe	LPC1	100
	81741	Low Profile Collar for 1-1/2" Vent Pipe	LPC15	100
	81742	Low Profile Collar for 2" Vent Pipe	LPC2	100
	81743	Low Profile Collar for 3" Vent Pipe	LPC3	100
	81744	Low Profile Collar for 4" Vent Pipe	LPC4	100

**Caution:** Ensure any sealant, mastic, or adhesive used is compatible with Flexible PVC, Polypropylene, EPDM, and Silicone. Do not apply any substances on the collar portion of the flashing.

# TYPE B VENTILATION

## Type B Vent Flashings



81575

- 28 gauge G-90 ASTM-A653 CS Galvanized steel
- Conical shape allows adjusting from 0/12 to 8/12 roof pitch
- Steep pitch models adjust from 8/12 to 12/12 roof pitch
- Cone and base seams have sealant on the inside of flashing
- Complies with ANSI / UL 441

PRODUCT	DESCRIPTION	MODEL	UNITS/CASE
81575	3" Type B Flashing	TB3	12
81576	4" Type B Flashing	TB4	12
81577	5" Type B Flashing	TB5	12
81578	6" Type B Flashing	TB6	12
81579	7" Type B Flashing	TB7	6
81580	8" Type B Flashing	TB8	6
81585	3" Type B Flashing – Steep Pitch	TB3SP	12
81586	4" Type B Flashing – Steep Pitch	TB4SP	12

## Multi-Cap™ Type B Vent Caps



81694

- Recommended for flue, hot stack, or Type B installations.
- Constructed from heavy-duty aluminum for durability.
- Resists rust and corrosion, ensuring long-lasting performance.
- Prevents weather, debris, and birds from entering the flue
- Non-clogging positive draft design
- Clamp fittings adjustable for all standard sizes
- Aluminum construction
- Complies with ANSI / UL 441

PRODUCT	DESCRIPTION	MODEL	UNITS/CASE
81694	Type B-Vent Cap, for outside diameter of 2-7/8" to 4-7/8"	VC35	12
81695	Type B-Vent Cap, for outside diameter of 4-7/8" to 6-7/8"	VC57	12
81696	Type B-Vent Cap, for outside diameter of 6-7/8" to 8-7/8"	VC79	12
81697	Type B-Vent Cap, for outside diameter of 8-7/8" to 10-7/8"	VC911	1
81698	Type B-Vent Cap, for outside diameter of 11-7/8" to 14"	VC1214	1

## Type B Vent Adjustable Storm Collars

- 28 gauge G-90 ASTM-A653 CS Galvanized steel
- Adjustable slip fit tab provides snug fit around vent
- Locking tab secures installation
- 7"-9" storm collar accomodates multi-sizes.
- Complies with ANSI / UL 441

PRODUCT	DESCRIPTION	MODEL	UNITS/CASE
81587	3" Type Adj Storm Collar	SC3	24
81588	4" Type Adj Storm Collar	SC4	24
81589	5" Type Adj Storm Collar	SC5	24
81590	6" Type Adj Storm Collar	SC6	24
81591	7-9" Type Adj Storm Collar	SC79	24

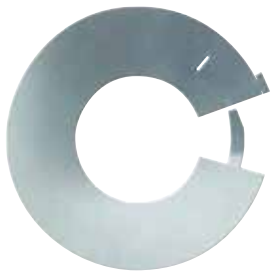

81587

## Stamped Storm Collar

- Works with Type B Vent flashing
- Provides a waterproof seal at roof stack penetration
- Storm collar is installed and sealed above the flashing.
- 28 gauge G-90 ASTM-A653 CS Galvanized steel
- Complies with ANSI / UL 441

PRODUCT	DESCRIPTION	MODEL	UNITS/CASE
81597	3" Type B Storm Collar Stamped	SC3S	24
81598	4" Type B Storm Collar Stamped	SC4S	24
81601	5" Type B Storm Collar Stamped	SC5S	24
81602	6" Type B Storm Collar Stamped	SC6S	24



81597

# SPECIALTY ROOFING PRODUCTS

## Multi-Size 3-8 Flashing



81499

- For pipe sizes 3"–8"
- Sleeve flexibility absorbs vibration and pipe movement caused by expansion/contraction
- Made of EPDM which are compounded specifically for maximum resistance to weathering due to ozone and ultraviolet light
- Easy on-site customization with pull tab design can accommodate all normal installation
- 20° pitch to accommodate 12/12 roof pitch
- Large footprint 22 gauge dead soft aluminum base
- EPDM is lab tested and certified: IAPMO PS64-2012ea1

LISTINGS	PRODUCT	DESCRIPTION	MODEL	UNITS/CASE
	81499	Multi-Size 3-8 Aluminum Base Flashing	DSALUF38	10

## Specialty Solar Collars & Flashings



81870

- Commercial & residential: water-tight seal for solar mounting system
- Requires no mastic, caulking or taping – mess free

PRODUCT	DESCRIPTION	MODEL	UNITS/CASE
81870	8-3/4" x 12-1/2" Galvanized Base for 1/2", 3/4" or 1" Tubing	GB5	20
81879	18" x 18" Galvanized Base for 1/2", 3/4" or 1" Tubing	GB518	15
81916	8-3/4" x 12-1/2" Aluminum Base for 1/2", 3/4" and 1" Tubing	AB5	20
81937	18" x 18" Aluminum Base for 1/2", 3/4" or 1" Tubing	AB518	15

## Electrical Mast Roof Flashing



81731

- Constructed of UV stabilized flexible PVC with proven track record of 40 years
- Equipped with multi-piece stainless steel clamps
- Tongue and groove design for increased weather protection
- Limited Lifetime Warranty for life of the current roof system
- Available in two sizes

PRODUCT	DESCRIPTION	MODEL	UNITS/CASE
81731	Electrical Mast RetroFit Roof Flashing, 0 to 3-1/2" – 13-1/4" x 11" Base	EFB1	15
81732	Electrical Mast RetroFit Roof Flashing, 0 to 5" – 14" x 15" Base	EFB2	15

## Mushroom Vent Cap



81753

- Fully assembled for easy installation
- Made from heavy-duty PVC that stands up to rain, hail, snow, and UV rays
- Stainless steel hex head bolts are corrosion resistant
- Charcoal gray cap compliments any type or color roof
- Product can be installed on 3" or 4" Schedule 40 pipe
- Will work on other exterior pipes that need protection

PRODUCT	DESCRIPTION	MODEL	UNITS/CASE
81753	Mushroom Vent Cap for 3- or 4-inch pipes	34MCL	5

**Caution:** Ensure any sealant, mastic, or adhesive used is compatible with Flexible PVC, Polypropylene, EPDM, and Silicone. Do not apply any substances on the collar portion of the flashing.

## IMPROVE YOUR EAVE INTAKE

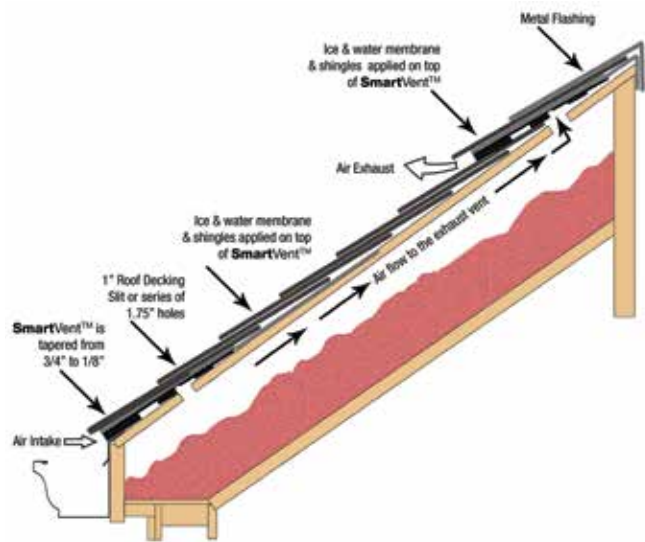
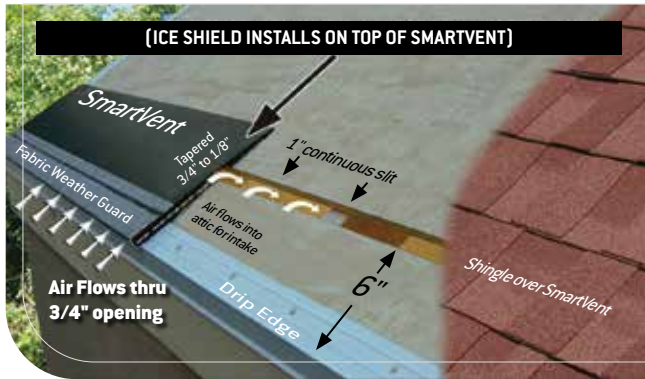

### EASIER INSTALL

SmartVent™ is light weight, nail gunnable, easy to cut with a knife and keeps the roofer on the roof.

### LIFETIME WARRANTY

SmartVent™ carries a warranty for the lifetime of the roof on which it is installed.

### UNMATCHED VERSATILITY

SmartVent™ offers a continuous venting area that can be used all the way up the roof from eave to ridge.

### BETTER SOLUTION

SmartVent™ is unnoticeable from the ground, provides cross-channel airflow to the exhaust vents and is an alternative for soffits that could be blocked.

### ICC-ES APPROVED

ESR-2484

## SmartVent Off Peak

### SmartVent

- Use on eaves, mid-roof, off-wall, shed-wall, off-peak, dormer and valley
- Intake or exhaust for all climates
- 9 square inches of NFA per linear foot (18 when used on both sides)
- Tapered for a natural look
- Fabric Weather Guard protects against rain and snow infiltration

PRODUCT	DESCRIPTION	MODEL	UNITS/CASE
80750	SmartVent™ (3' per unit)	SV1	18



80750

### SmartVent Tapered End Caps

- Provides a perfectly tapered end to SmartVent™
- Eliminates the need to fabricate end caps on the job
- Fabric Weather Guard protects against rain and snow infiltration
- Creates a watertight seal as the shingles slope down
- Universal pieces install on right side or left side of the SmartVent run

PRODUCT	DESCRIPTION	MODEL	UNITS/CASE
80751	SmartVent™ End Caps	SVEC	12



80751

## THE ALL-PURPOSE INTAKE & EXHAUST SOLUTION

### MID-ROOF & OFF WALL

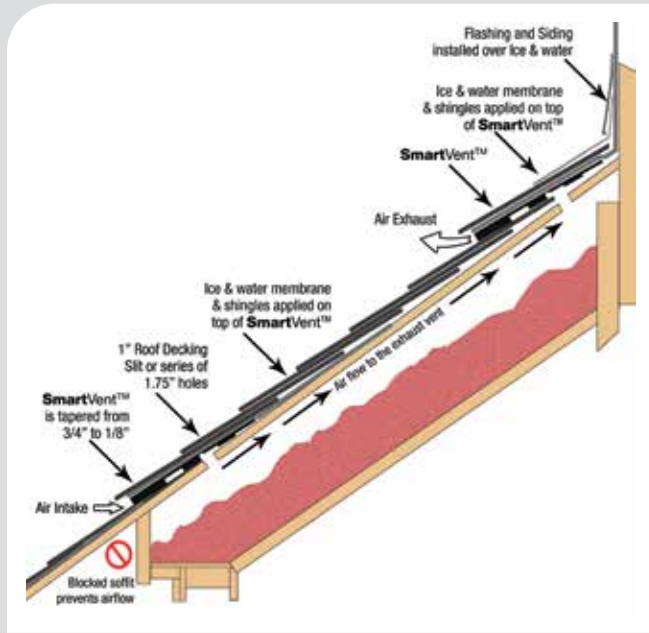

### SHED ROOF

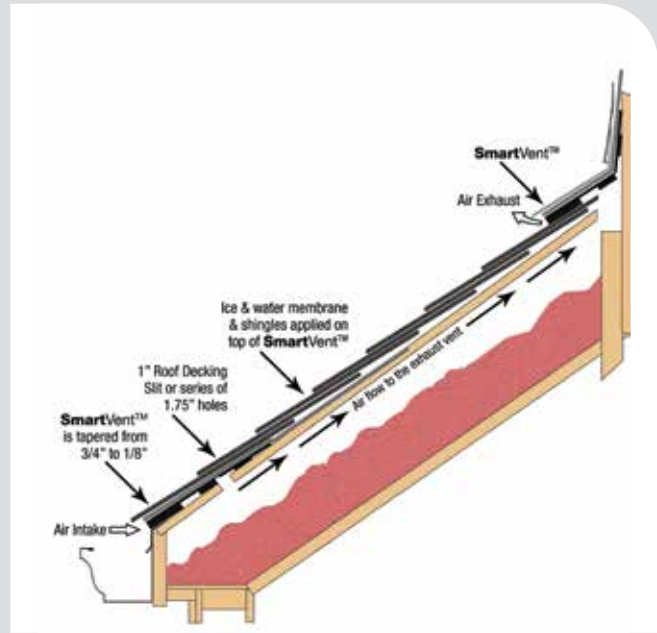

### DORMER PEAK

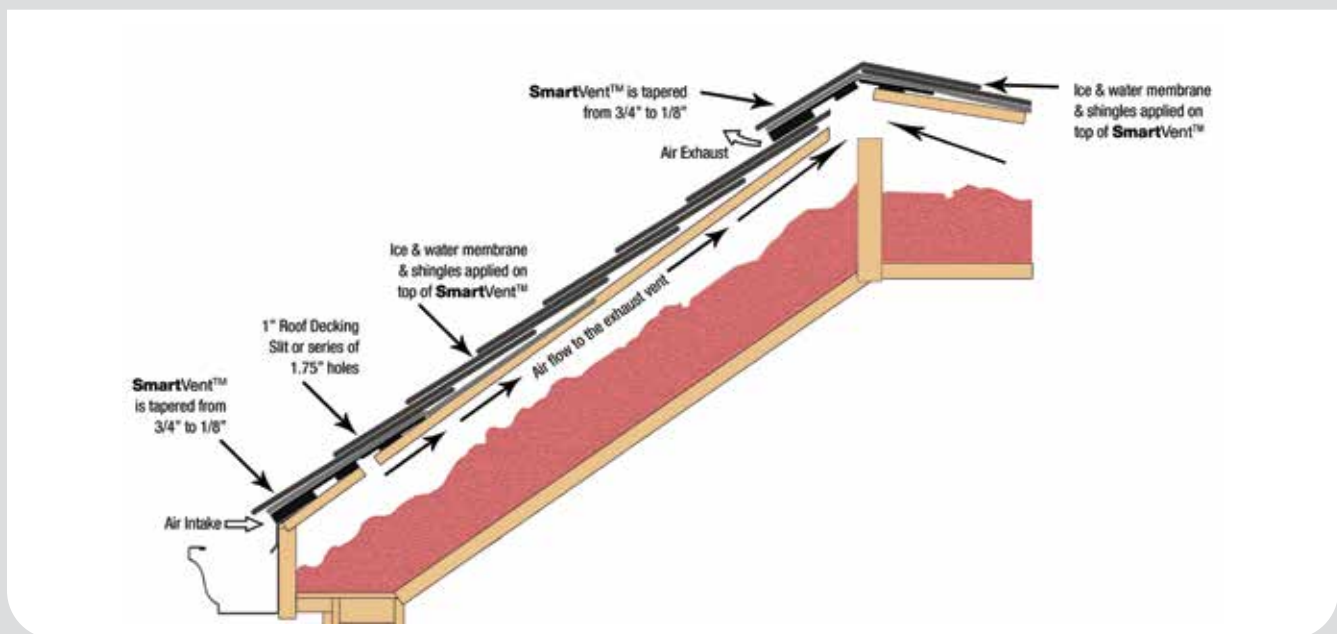

## SmartRidge™ I

### One Sided Ridge Ventilation

IPS SmartRidge™ I is the most efficient ridge exhaust system. By exhausting air on one side, the SmartRidge™ I siphons 100% attic exhaust without pulling in exterior air, rain, snow or ice from the opposite side of the vent. The SmartRidge™ I produces a natural look with no street side lift making it the most effective and cleanest looking ridge vent system.

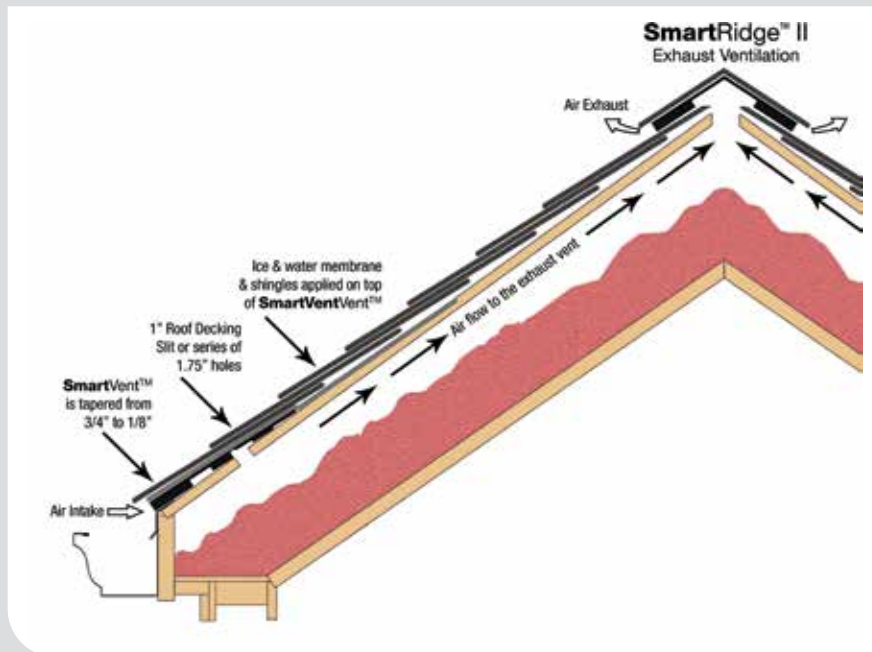
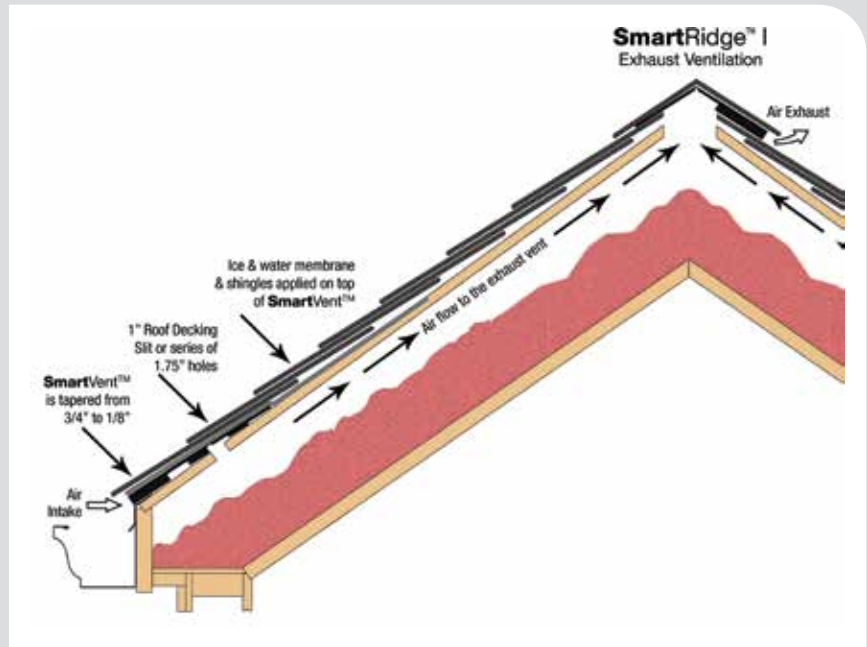
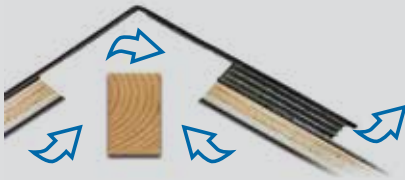

## SmartRidge™ II

### Two Sided Hip & Ridge Ventilation

IPS SmartRidge™ II is a versatile vent that can be used for hip and ridge ventilation. Equipped with protective weather fabric, the SmartRidge™ II prevents rain, sleet and snow from penetrating the attic and damaging the roof structure. SmartRidge™ II cuts with a utility knife and can be hand or nail gunned for easy install.





## ValleyVent™

- Provides airflow in difficult-to-ventilate and obstructed areas
- Polyethylene construction is easy to handle and install
- Helps prevent ice dams, "hot spots" and mold growth
- Increases the efficiency of the ventilation system

PRODUCT	DESCRIPTION	MODEL	UNITS/CASE
80756	ValleyVent™ (2' per unit)	W1	84



80756

## SmartRidge™ I



80752

- 100% attic exhaust
- No street side lift for improved appearance
- Fabric Weather Guard protects against rain and snow infiltration
- Equivalent to 18 square inches of NFA
- Achieves a balanced ventilation system with SmartVent™
- Easy to cut and install

PRODUCT	DESCRIPTION	MODEL	UNITS/CASE
80752	SmartRidge™ I (3' per unit)	SR1	16

## SmartRidge™ II



80753

- Fabric Weather Guard protects against rain and snow infiltration
- 18 square inches of NFA
- Achieves a balanced ventilation system with SmartVent™
- Easy to cut and install

PRODUCT	DESCRIPTION	MODEL	UNITS/CASE
80753	7" SmartRidge™ II (3' per unit)	SR27	24
80754	8.5" SmartRidge™ II (3' per unit)	SR285	16
80755	10.5" SmartRidge™ II (3' per unit)	SR2105	12



## SnapCap™

### Bathroom, Kitchen, & Dryer Exhaust Vent Cap

SnapCap™ is the highest performance, most versatile bathroom, kitchen, and dryer exhaust vent cap available. Equipped with a counterbalanced damper, SnapCap works with any CFM fan and provides a secure connection to 3", 4" and 6" flexible or rigid duct. SnapCap™ is constructed of heavy gauge aluminum or galvanized steel to provide unmatched durability and is backed by a Life of the Roof™ warranty. Each SnapCap™ package includes an adapter set and cable tie.

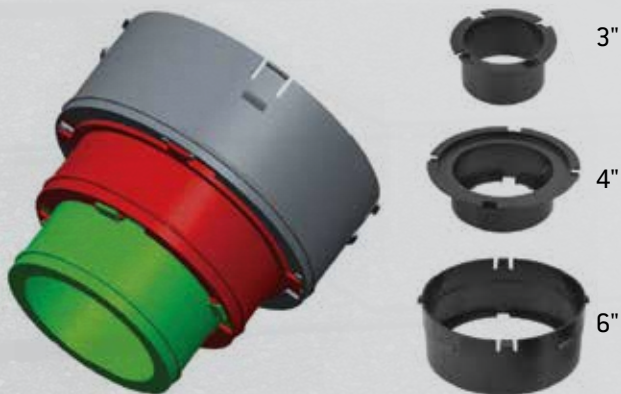
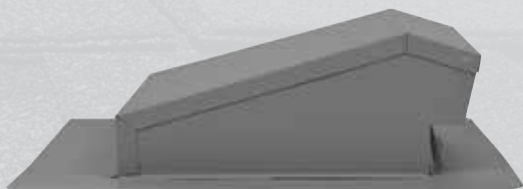

### Low-Profile, Durable Gauge Design

SnapCap™ has a lower profile on the roof and a heavier gauge base and housing for improved aesthetics and increased performance. SnapCap™ is available in aluminum and galvanized steel.

### Easy "Snap-In" Installation

SnapCap™ adapters easily snap into the vent cap for a secure connection.



Brown



Black



Gray

### Three Powder-Coated Finishes Available

SnapCap™ is available in Galvanized Black brown and Gray and Black Aluminum to match most roofing systems.

Easily connect ductwork with a cable tie, duct tape, or a sheet metal screw

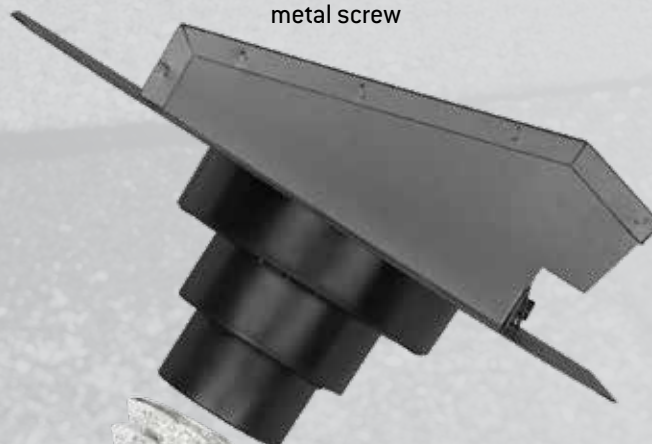

## GALVANIZED STEEL SNAPCAP™

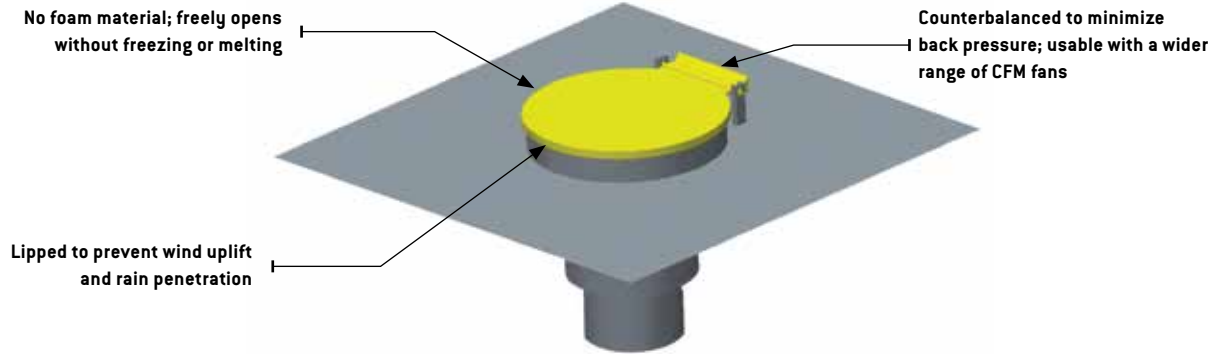

### Galvanized Steel SnapCap™

- All-Flow™ capability: patented counterbalanced damper works with any CFM fan
- 3", 4", & 6" adapters for multiple application sizes
- Heavy gauge flange and housing
- Three powder coated finishes available
- Adapter set and cable tie included with each SnapCap™

PRODUCT	DESCRIPTION	MODEL	UNITS/CASE
81680	 SnapCap – Brown Galvanized Steel	SCBRG	1
81681	 SnapCap – Black Galvanized Steel	SCBLG	1
81682	 SnapCap – Gray Galvanized Steel	SCGRG	1



81680

### Aluminum SnapCap™

- All-Flow™ capability: patent pending counterbalanced damper works with any CFM fan
- 3", 4", & 6" adapters for multiple application sizes
- Heavy gauge flange and housing
- Three powder coated finishes available
- Adapter set and cable tie included with each SnapCap™

PRODUCT	DESCRIPTION	MODEL	UNITS/CASE
81684	 SnapCap – Black Aluminum	SCBLAL	1



81684

# COMMERCIAL ROOFING PRODUCTS

## APE-2000 One-way Air Pressure Equalizer



99100

**DIMENSIONS:**

Height: 11.25"

Base Diameter: 11.00"

Stack Diameter: 6.00"

Cap Height: 4.25"

Recommended for all types of roofing systems.

*NOTE: Available with or without one-way insert. Also available with removable caps (please specify).*

- .063 gauge aluminum
- "One-way air pressure equalizer" vent system
- Constructed of heavy gauge aluminum
- Fully insulated to eliminate condensation
- Engineered to withstand extended exposure to the elements without deterioration
- Will reduce the risk of ballooning, blow-offs, graver spreading, deterioration of roof insulation and deck seam separation
- 20-year warranty

PRODUCT	DESCRIPTION	MODEL	UNITS/CASE
99100	APE 2000 W/Tite-Top & Insulator, One Way	APE2000WTT	4
99101	APE 2000 W/Tite-Top No Insulator, Two Way	APE2000WOTT	4
99102	APE 2000 W/Removeable Top & Insulator, One Way	APE2000WRT	4
99103	APE 2000 W/Removeable Top, No Insulator, Two Way	APE2000WORT	4

## Ballard JL-10 One-way Vent



99104

**DIMENSIONS:**

Height: 9.75"

Base Diameter: 11.25"

Stack Diameter: 4.00"

Cap Height: 1.50"

Recommended for all types of roofing systems.

- .063 gauge aluminum
- "One-way" vent system
- Constructed of heavy gauge aluminum, and fully insulated to eliminate condensation
- One piece spun aluminum construction eliminates the possibility of split seams and blown off caps
- Layer of one-way fabric allows moisture and air to escape, but not to enter the roofing system
- Unlike other vents on the market, there are no moving parts to wear out or clog due to insects or debris
- 20-year warranty

PRODUCT	DESCRIPTION	MODEL	UNITS/CASE
99104	Ballard JL-10 W/Tite-Top & Insulator, One Way	JL10	10

## Jimco SJL-3 Economy Vent

Recommended for all types of roofing systems. Install one vent per 900 sq. ft. of roof area.

*NOTE: Available with or without one-way EPS insert (please specify)*

- .063 gauge aluminum
- "Economy one-way" vent system
- Constructed of heavy gauge aluminum
- Fully insulated to eliminate condensation
- Layer of one-way fabric that allows moisture and air pressure to escape, but not enter the roofing system
- Factory secured Tite Top design omits any possibility of backwash and cannot become detached from the main stack
- 20-year warranty
- JIMCO LT

PRODUCT	DESCRIPTION	MODEL	UNITS/CASE
99105	SJL-3 W/Tite-Top & Insulator, One-Way	SJL3W	20
99106	SJL-3 W/Tite-Top & Insulator, Two-Way	SJL3W0	20



99106

**DIMENSIONS:**

Height: 8.50"  
 Base Diameter: w8.00"  
 Stack Diameter: 3.00"  
 Cap Height: 2.50

## Jimco LT-6 One-ay Air Pressure Equalizer

Recommended for all types of roofing systems. Used also as a mobile home and trailer fan replacement vent.

- .063 gauge aluminum
- Designed to withstand extended pressure and air moisture trapped within the roofing system, for the purpose of allowing pressure (air moisture) to escape
- Constructed of heavy spun aluminum
- 20-year warranty

PRODUCT	DESCRIPTION	MODEL	UNITS/CASE
99107	LT-6 W/Tite Top & Insulator, One Way	LT6WTT	8
99108	LT-6 W/Tite Top, No Insulator, Two Way	LT6WOTT	8
99109	LT-6 W/Removable Top & Insulator, One Way	LT6WRT	8
99110	LT-6 W/Removable Top, No Insulator, Two Way	LT6WORT	8



99107

**DIMENSIONS:**

Height: 6.50"  
 Base Diameter: 10.25"  
 Stack Diameter: 6.00"  
 Cap Height: 4.25"

# COMMERCIAL ROOFING PRODUCTS

## Jimco Breather Vent



99111

### DIMENSIONS:

Height: 9.50"

Base Diameter: 11.00"

Stack Diameter: 4.25"

Cap Height: 2.50"

Recommended for all types of roofing systems. Install one vent per 1000 sq. ft. of roof area

- .063 gauge aluminum
- Constructed of a heavy gauge spun aluminum
- Designed to withstand prolonged exposure to the toughest elements without deterioration
- Cap has been engineered to eliminate any possibility of backwash
- Cannot become detached from the main stack, protecting it from the possibility of exposing breather holes to the elements
- 20-year warranty

PRODUCT	DESCRIPTION	MODEL	UNITS/CASE
99111	Jimco Breather Vent, Two-Way	JIMCO	10

## Jimco VJ-2 One Piece Vent



99115

### DIMENSIONS:

Height: 5.50"

Base Diameter: 10.25"

Stack Diameter: 6.00"

Cap Height: 1.20"

Recommended for all types of roofing systems. Install one vent per 1100 sq. ft. of roof area.

- .063 gauge aluminum
- Constructed of one piece heavy gauge spun aluminum
- Designed and fabricated to withstand extended exposure to the toughest elements without deterioration
- Low profile vent versatile for application on mobile homes, house trailers, etc.
- Large stack capacity able to handle a great amount of pressure from built-up or single ply roofs
- 20-year warranty

PRODUCT	DESCRIPTION	MODEL	UNITS/CASE
99115	VJ-2, Two-Way	VJ2	10

## Jimco CJ-30 Vent

Recommended for all types of roofing systems. Install one vent per 600 sq. ft. of roof area.

*NOTE: Also available with removable cap (please specify).*

- .063 gauge aluminum
- Constructed of heavy gauge spun aluminum
- Designed to withstand extended exposure to the toughest elements without deterioration
- Cap has been engineered to eliminate any possibility of backwash
- Cannot become detached from the main stack, protecting from the possibility of exposing the breather holes
- 20-year warranty

PRODUCT	DESCRIPTION	MODEL	UNITS/CASE
99112	CJ-30 W/Removable Top, Two-Way	CJ30RT	20
99113	CJ-30 W/Tite-Top, Two-Way	CJ30TT	20



99112

**DIMENSIONS:**

Height: 5.50"  
Base Diameter: 10.25"  
Stack Diameter: 6.00"  
Cap Height: 1.20"

## Jimco HT-20 Low Profile Vent

Recommended for all types of roofing systems. Install one vent per 200 sq. ft. of roof area.

- .063 gauge aluminum
- Low profile vent, mainly used in new construction of mobile homes, house trailers and also in the re-roofing industry
- Manufactured of a heavy gauge spun aluminum
- Cap design will not allow backwash
- 20-year warranty

PRODUCT	DESCRIPTION	MODEL	UNITS/CASE
99099	HT-20 With Tite Top, Two-Way	"HT20TT"	50
99114	HT-20 With Removable Top, Two-Way	"HT20"	50



99114

**DIMENSIONS:**

Height: 5.50"  
Base Diameter: 6.00"  
Stack Diameter: 3.00"  
Cap Height: 2.50"

## Roof Drain Kit

- Heavy duty plastic body
- 3" and 4" pipe sizes
- Clamping ring/gravel guard standard on all drains
- Two-piece underdeck clamp kits
- Accepts Schedule 40 pipe via a 3" or 4" Expansion Coupling
- Available with Plastic or Cast Iron Domes
- 20-year warranty

PRODUCT	DESCRIPTION	MODEL	UNITS/CASE
86096	3" PVC Roof Drain W/Cast Iron Dome	4863K	1
86106	4" PVC Roof Drain W/Cast Iron Dome	4864K	1
86097	3" PVC Roof Drain with Plastic Dome	4863PK	1
86107	4" PVC Roof Drain with Plastic Dome	4864PK	1



86096

Kits Include: Drain, underdeck clamp with hardware, expansion coupling, 4" section of PVC pipe and installation guide

# COMMERCIAL ROOFING PRODUCTS

## Retrofit Insert Roof Drains



86111

**DIMENSIONS:**

Height: 5.50"  
 Base Diameter: 6.00"  
 Stack Diameter: 3.00"  
 Cap Height: 2.50"

Recommended for all types of roofing systems.

- RetroFit drains with expandable anti-back-up seal(s)
- Constructed of a heavy gauge (.081)
- Spun Aluminum
- Bolt-in-place strainer dome
- 20-year warranty

PRODUCT	DESCRIPTION	MODEL	UNITS/CASE
86111	Drain Pipe Size: 3" Outlet Outside Diameter: 2.75" Outlet Length: .727"	86111	6
86112	Drain Pipe Size: 4" Outlet Outside Diameter: 3.75" Outlet Length: .727"	86112	6
86113	Drain Pipe Size: 6" Outlet Outside Diameter: 5.75" Outlet Length: .727"	86113	6

## Commercial Roof Drains & Accessories



86115



86125



87580

PRODUCT	DESCRIPTION	MODEL	UNITS/CASE
86115	3" PVC Roof Drain W/Plastic Dome	4865	1
86120	3" ABS Roof Drain W/Plastic Dome	5865	1
86095	3" PVC Roof Drain W/Cast Iron Dome	4863	1
86100	3" ABS Plastic Roof Drain W/Cast Iron Dome	5863	1
86121	4" PVC Roof Drain W/Plastic Dome	4866	1
86122	4" ABS Roof Drain W/Plastic Dome	5866	1
86105	4" PVC Roof Drain W/Cast Iron Dome	4864	1
86110	4" ABS Plastic Roof Drain W/Cast Iron Dome	5864	1
86125	Underdeck Clamping Collar W/ Hardware, 3" or 4" Roof Drain	5555	1
89522	Plastic Dome	89522	5
89527	Cast Iron Dome	89527	5
87580	3" Rubber Expansion Coupling	87580	20
87585	4" Rubber Expansion Coupling	87585	20



## Cast Iron Roof Drain

- 6-1/2" dome
- Available with bottom or side outlet

- Limited Lifetime Warranty for life of the current roof system

PRODUCT	DESCRIPTION	MODEL	UNITS/CASE
60213	3" No-hub Bottom Outlet	ABA573	1
60214	4" No-hub Bottom Outlet	ABA574	1
60215	2" No-hub Side Outlet	ABA582	1
60216	3" No-hub Side Outlet	ABA583	1



60213

## Cast Iron Roof Drain

- Overflow combo
- 8 -3/4" CD
- 6-1/2" dome

- Limited Lifetime Warranty for life of the current roof system

PRODUCT	DESCRIPTION	MODEL	UNITS/CASE
60219	2" No-hub Outlet	ABA602	1
60220	3" No-hub Outlet	ABA603	1
60222	4" No-hub Side Outlet	ABA604	1
60218	6-1/2" Dome with Ring & Hardware	ABA586	1



60219

**DIMENSIONS:**

Height: 5.50"  
 Base Diameter: 6.00"  
 Stack Diameter: 3.00"  
 Cap Height: 2.50"

## Multi-Purpose Towels

- Heavy Duty/ Pre-Moistened
- Removes Embedded Grime Easily

- 90 Towels Per Dispenser

PRODUCT	DESCRIPTION	MODEL	UNITS/CASE
512975	Multi-Purpose Towels	RH-PW1	6



512975

## Roof Top Blox® Adjustable Pipe Support



80600

- Made of Polypropylene Copolymer
- Bundled in 8 pack totes
- Includes on-board galvanized strap
- 250 lbs. max weight single point
- 350 lbs. max weight with strut
- Perfect solution for supporting piping and equipment on flat commercial roofs

LISTINGS	PRODUCT	DESCRIPTION	MODEL	UNITS/CASE
	80600	Roof Top Blox-Adj Pipe Support (8-pack)	RTB01	8

## 1.5" Blox Height Extension



80601

- Fastens directly on top of Blox
- Two #10 screws provided
- Use to elevate Blox to 6" overall height
- 100 lbs./45 kg max loads when directly mounted to blox or when elevated on threaded rods
- Available in 24 or 48 packs

PRODUCT	DESCRIPTION	MODEL	UNITS/CASE
80601	1.5" Blox Height Extension	XTB0224	24

## Securing Brackets



80607

- Pair of securing brackets secure Blox directly to roof surface
- Help to secure Blox to protect against moderate wind, water and snow loads
- Brackets lock onto engineered mounting tabs with two #12x3/4" screws, then glue to roof surface with structural adhesive

PRODUCT	DESCRIPTION	MODEL	UNITS/CASE
80607	Securing Bracket (1 pair)	SCB07	32

## Small & Large Pipe Rollers



80605

80611

- Small aluminum roller supports 1" - 3" diameter pipe
- Large aluminum roller supports 4" - 6" diameter pipe
- Use on long pipe runs to allow for expansion and contraction of piping
- Can be mounted centrally or side by side on Blox
- Can be mounted directly on Blox or elevated with extension rods (R0D03)
- Includes strut, bolts and mounting screws (Large rollers only)

PRODUCT	DESCRIPTION	MODEL	UNITS/CASE
<b>Small Pipe Rollers</b>			
80605	1" - 3" Small Pipe Roller	ROL05	16
80611	1"-3" Small Pipe Roller Less Containment Band	ROL08	16
<b>Large Pipe Roller</b>			
80606	4" - 6" Large Pipe Roller	ROL06	8



80606

## 12" Extension Rods

- 11-1/2" long, 1/2" diameter zinc coated threaded rods with nuts and washers
- Use with XTBO2, STRO4, ROL05 or ROL06 to elevate piping up to 14" overall height
- Insert rods a minimum of 1" into blox, not to exceed 3"

PRODUCT	DESCRIPTION	MODEL	UNITS/CASE
80603	12" Extension Rods	ROD03	24

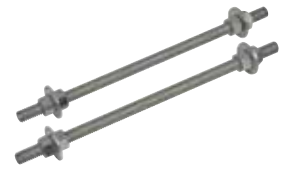

80603

## 10" Galvanized Slotted Strut

- Mounts directly to Blox top with #14x1 sheet metal screws and washers
- Can also be installed elevated with threaded extension rods
- Accepts strut clamps
- 350 lbs./158 kg max. static load when strut is applied to Blox

PRODUCT	DESCRIPTION	MODEL	UNITS/CASE
80604	10" Slotted Steel Strut	STRO4	24



80604

## M-1® Structural Adhesive

- Non-solvent based, flexible, high-bond M-1 adhesive
- 10 oz. tube bonds 10 pairs of SCB07
- Bonds SCB07 Securing Brackets to all roof surfaces and materials
- Available in gray or white (Not to be applied under Blox)

PRODUCT	DESCRIPTION	MODEL	UNITS/CASE
80608	Structural Adhesive, Gray	ADH12	24
80609	Structural Adhesive, White	ADH12WH	24



80608

## Primer for M-1® Adhesive

- Primer required for bonding with ADH12 to TPO roofing systems.
- One pint primes TPO membranes for 35 pairs of Securing Brackets

PRODUCT	DESCRIPTION	MODEL	UNITS/CASE
80610	TPO Primer, F1280 (pint)	PRI13	4



80610



**IPS Corporation**

500 Distribution Parkway  
Collierville, TN 38017

800-888-8312  
901-853-5008 fax

**IPSRoofingProducts.com**

ips.roofing@ipscorp.com

---

R00F001 12/2024